

nuroum

AW10

Conference Speakerphone



User Guide

www.nuroum.com

Contents

Package Includes	1
Functions	2
Product Overview	3
Overview of the Speakerphone	4
Overview of the Side	4
Overview of LED Indicators	5
Power On/Off LED	5
Answer/Hang-Up Call LED	5
Bluetooth LED Status	6
USB LED Status	6
Speaker Mute	7
Firmware Update	7
Charging Indicator	7
Setting Up NUROUM AW10	8
Using the Speakerphone	9
Power On/Off/Restart	9
Volume Down	9
Answer/Hang Up	9
Volume Up	10
Mute	10
Connecting via USB Cable	11
Connecting via Bluetooth	12
Switch Between Bluetooth and USB Connection	13
Charging Device	14
Connect	15
Download the NUROUM App	15
Firmware Update	15
Device name modification	15
Notes & Warnings	16
Product Specification	17

Package Includes

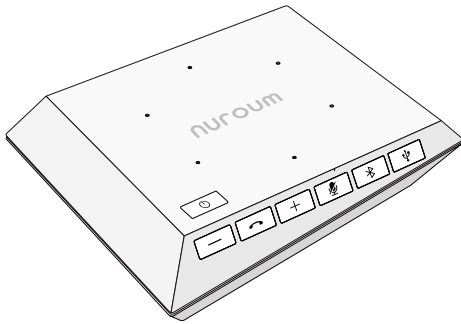

NUROUM AW10
Conference Speakerphone

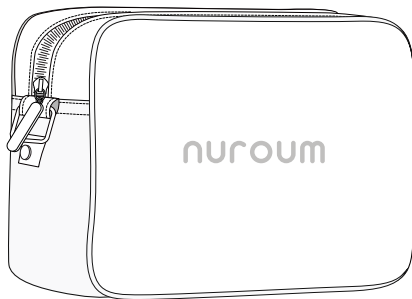

Portable splash-proof Pouch

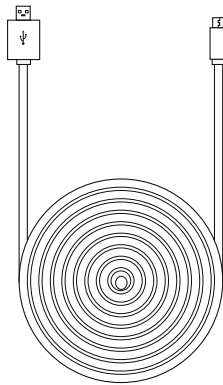

USB Cable

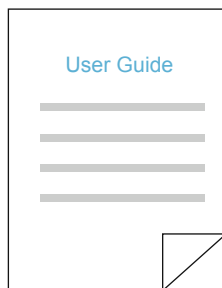

User Guide

Functions



Offers high acoustic clarity, thanks to our generous 6-element Microphone Beamforming technology.



Completely echo-free, finely tuned for various acoustic environments.



Up to 12 feet Far-field speech pickup.



Outstanding speaker quality tuned for both phone calls and music playback.



Answer, Hang-up, reject and mute calls.

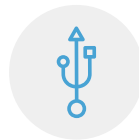

Connect to PC via USB, Plug & Play.



Connect wirelessly to mobile devices or laptop via Bluetooth.



Portable design with easy-to-carry protection pouch.

Product Overview

Overview of the Speakerphone

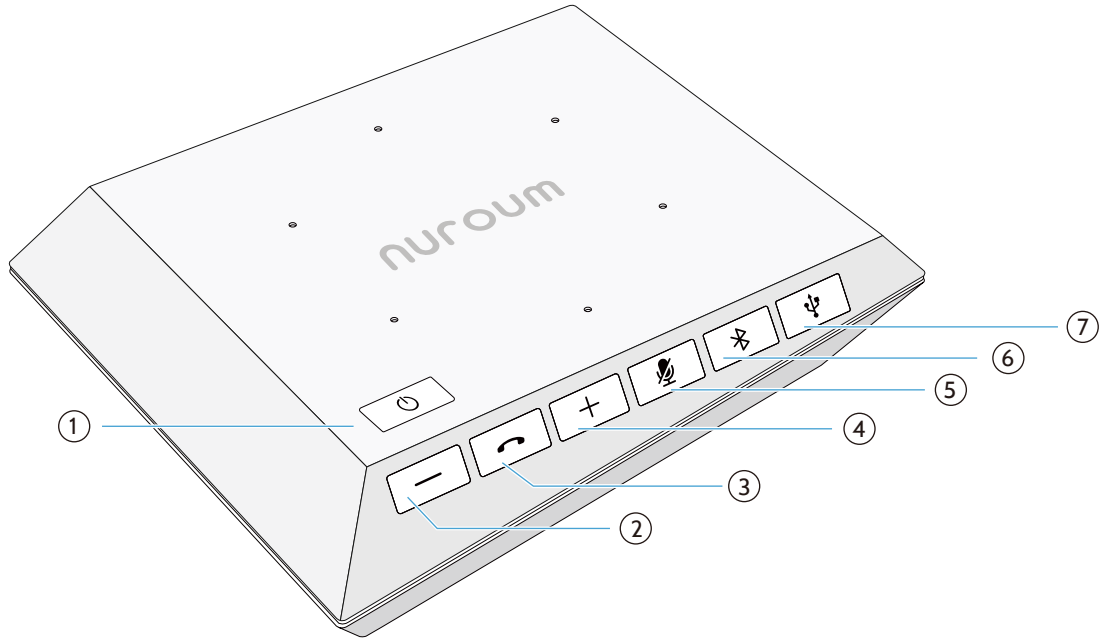



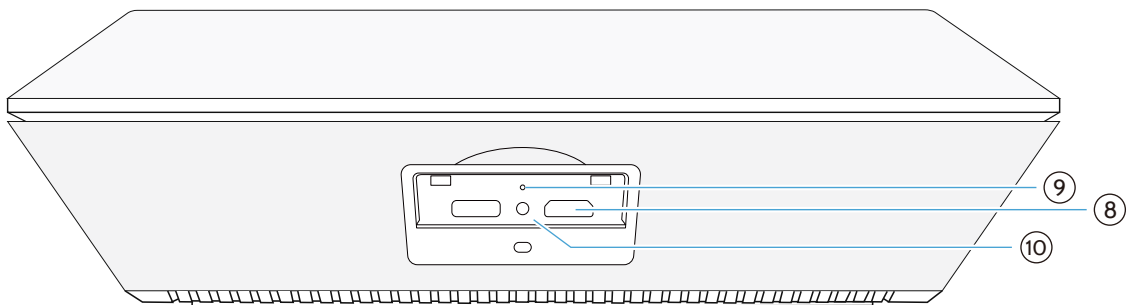

Overview of the Side Ports



- | | |
|-------------------|-----------------------|
| ① On/Off | ② Volume Down |
| ③ Answer/End Call | ④ Volume Up |
| ⑤ Mute Microphone | ⑥ Switch to Bluetooth |
| ⑦ Switch to USB | ⑧ USB Port |
| ⑨ Reset | ⑩ Charging Indicator |

Overview of LED Indicators

Power On/Off LED

	Battery level over 25%
	Battery level between 10% and 25%
	Battery is less than 10%
	Speakerphone will automatically turn off in 30 seconds due to critically low battery level
	Speakerphone will automatically turn off in 30 seconds due to idle status over 15 minutes

** LED color may vary by battery level*

Answer/Hang-Up Call LED

	Incoming or active call
---	-------------------------

Overview of LED Indicators

Bluetooth LED Status



Bluetooth standby or searching for the previously paired Bluetooth devices



Indicates speakerphone in Bluetooth pairing mode



Bluetooth device connected

USB LED Status



Speakerphone in USB pairing mode



USB device connected

Overview of LED Indicators

Speaker Mute



Speaker Mute

Firmware Update



Firmware update in process

Charging Indicator



Battery charging in process. The indicator will turn off when it is fully charged.

Setting Up NUROUM AW10

Register your device to get an extra warranty period

www.nuroom.com

01

Turn on the speakerphone:

Press and hold the Power On/Off button for 2 seconds until the LED indicator lights white.

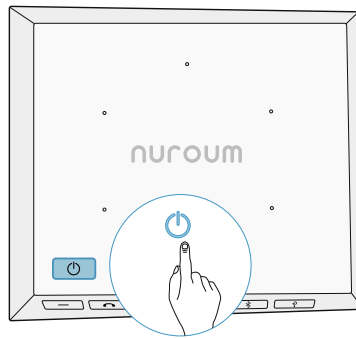

02

If you want to establish a USB connection:

Connect your speakerphone to your computer (or other compatible devices) with the included USB cable. USB indicator turns from white to blue, indicating that the USB connection is established successfully.

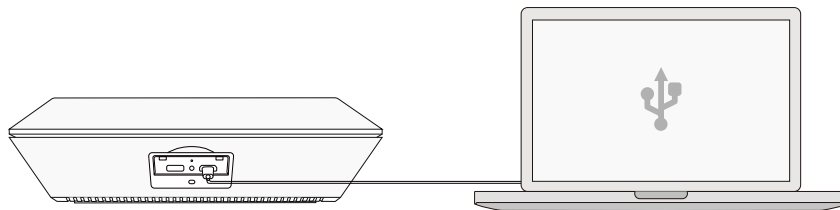

03

Otherwise, if you want to establish a Bluetooth connection:

Enable Bluetooth on your mobile device (or other compatible devices), and select Nuroum AW10 from the list of available Bluetooth devices. Bluetooth indicator stops flashing and lights blue, indicating that the Bluetooth connection is established successfully.

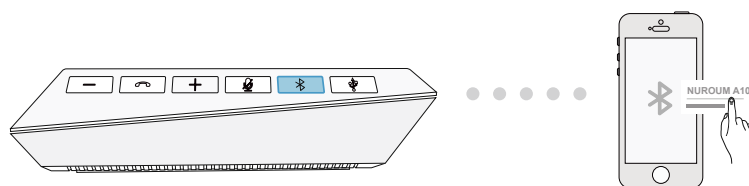

Using the Speakerphone

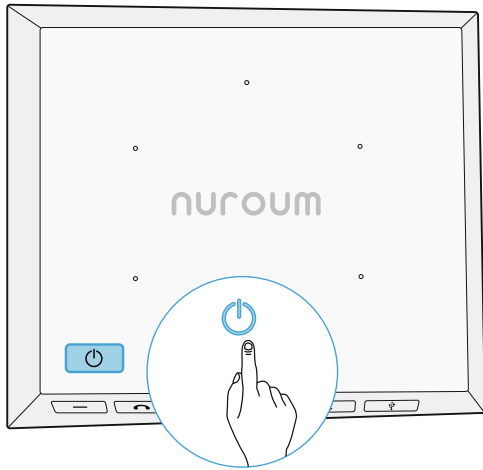

Power On/Off and Restart

Press and hold the button for 2 seconds to turn the speakerphone on or off.

Press and hold the button for 10 seconds to restart (reboot) the speakerphone.

****Turn off the device where it is prohibited.***

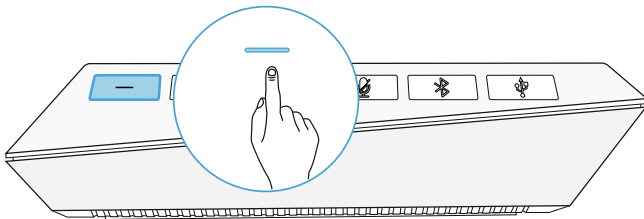

Volume Down

Press the button to decrease the volume.

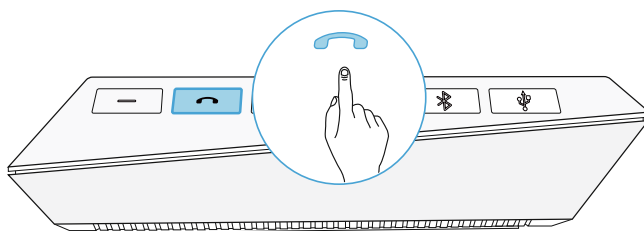

Answer / Hang Up

Press the button to answer an incoming call.

Press the button during a call to hang up.

Using the Speakerphone

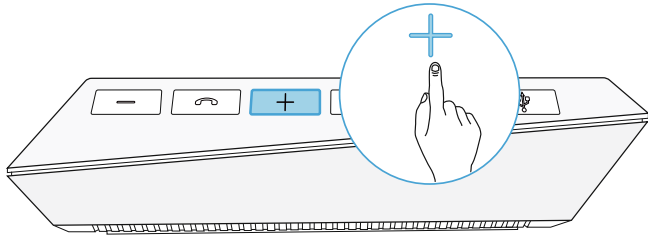

Volume Up

Press the button to increase the volume.

****Constant high volume sound has a negative impact on human hearing.***

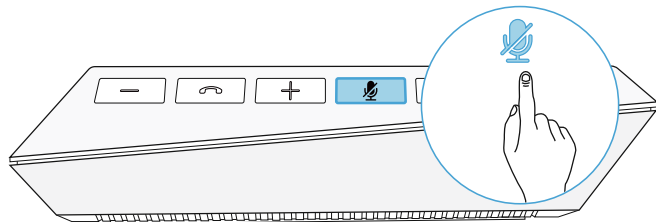

Mute

Press the button to mute or unmute the microphone.

Connecting via USB Cable

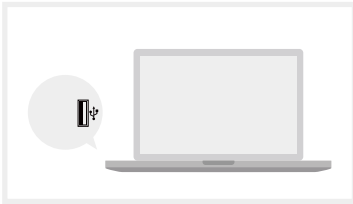

- Connect NUROUM A10 to your computer's USB port via USB cable.
- Press the USB button if the USB button indicator is off.
- The USB connection will be established.

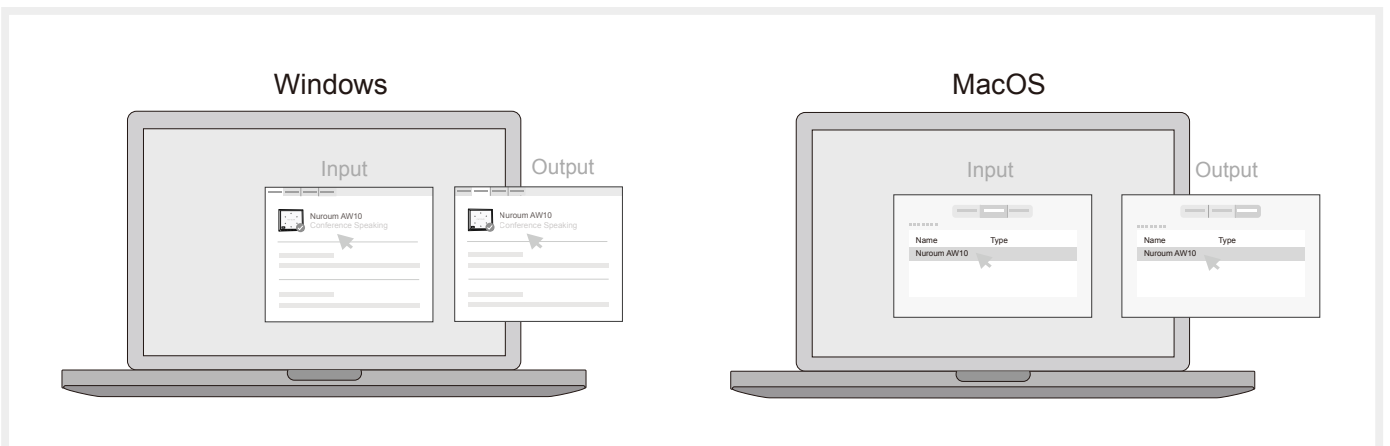
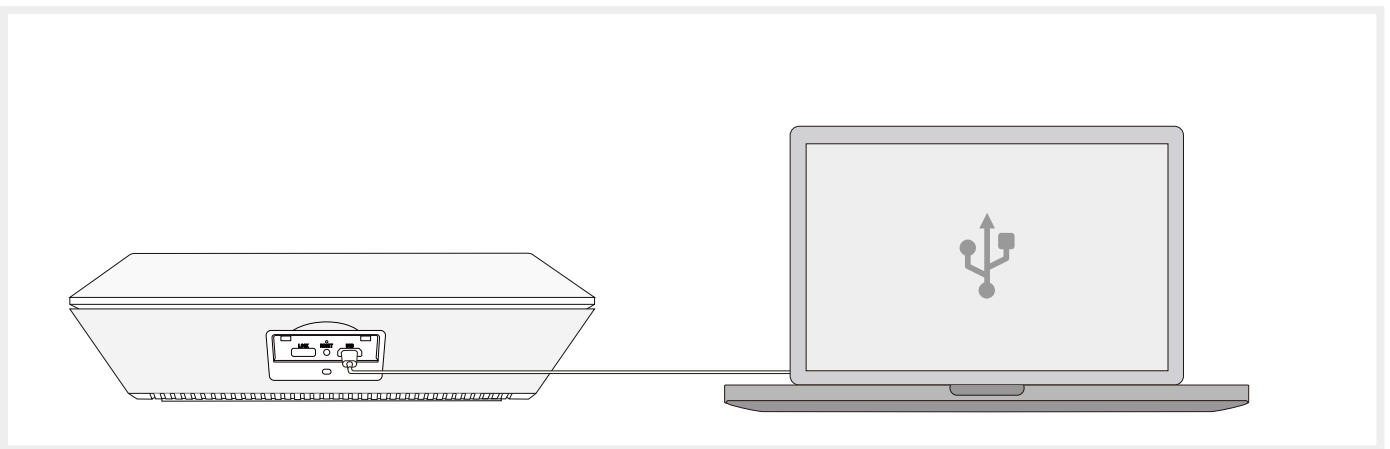

****If the speakerphone doesn't work as expected, please check and select NUROUM AW10 as the default audio device in Windows Control Panel sound settings, or macOS System Preferences sound setting, and in your softphone audio settings.***

****The speakerphone doesn't allow simultaneous multiple connections. If the speakerphone is connected to your device via Bluetooth, the Bluetooth connection will be turned off once the USB connection is established.***

****The device will be charged while connected via USB (device dependent).***

Connecting via Bluetooth

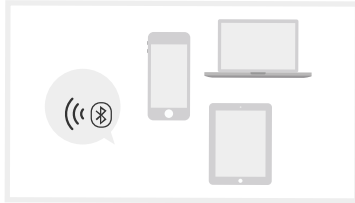

- To connect the speakerphone to a new Bluetooth device, press and hold (2 seconds) the Bluetooth button until the Bluetooth indicator flashes blue, and the speakerphone is in pairing mode.
- Enable Bluetooth on your mobile device, MacBook or Laptop (or other compatible Bluetooth devices), and select NUROUM AW10 from the list of available Bluetooth devices.
- When the Bluetooth indicator turns blue, it indicates that the Bluetooth connection is established successfully.
- When the speakerphone is in Bluetooth mode, it will attempt to connect the last paired device by Default.

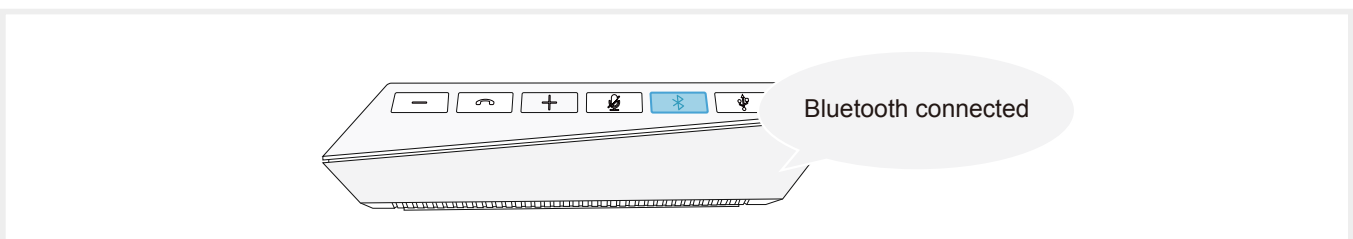
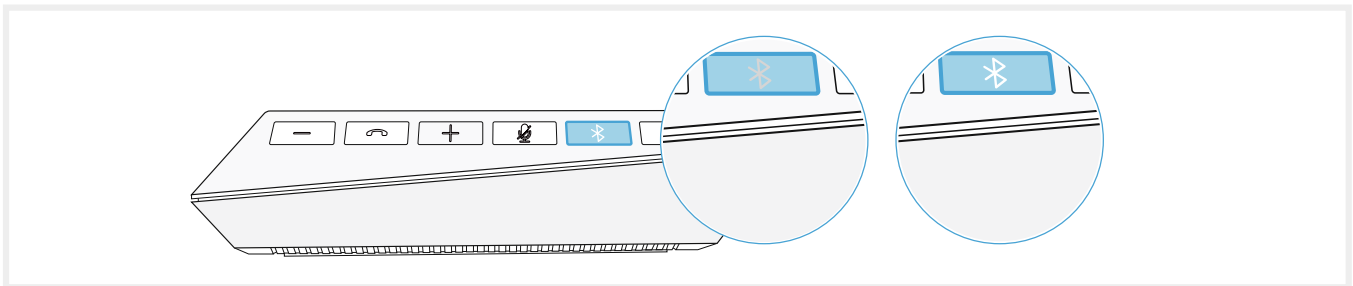

***The speakerphone doesn't allow simultaneous multiple connections. Any connected device will be disconnected when switching to another Bluetooth device.**

***The Search for previously paired device will timeout if no device is found afterwards, Bluetooth indicator turns to white in Standby mode.**

***The device can cause an interruption to other electrical devices and medical equipment.**

Switch between USB and Bluetooth Connection

- Press the USB or Bluetooth button accordingly to switch between different connections.

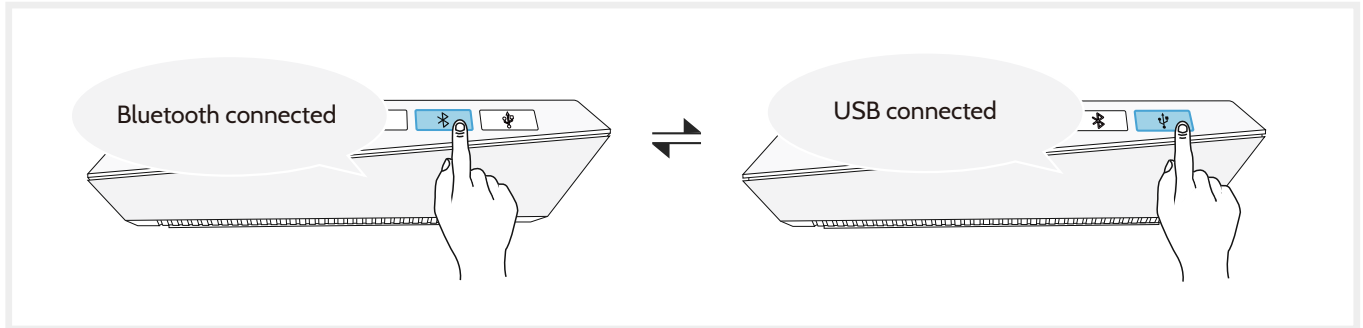

Charging Device

When the battery level drops below 10%, the Power On/Off indicator turns red. When the battery is empty, the speakerphone turns off automatically.

Charging the device every other month is recommended to protect the battery life, if you do not use the speakerphone for an extended period of time.

You can charge the speakerphone regardless of the power state (on or off). The charging indicator next to the micro-USB port on the speakerphone turns red when charging is in process, and turns off when charging finished.

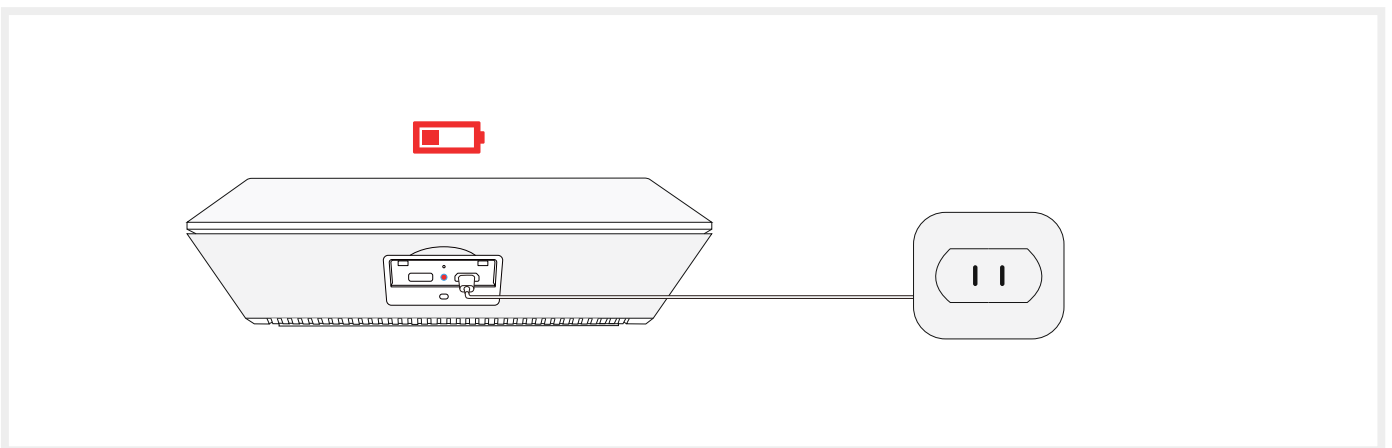
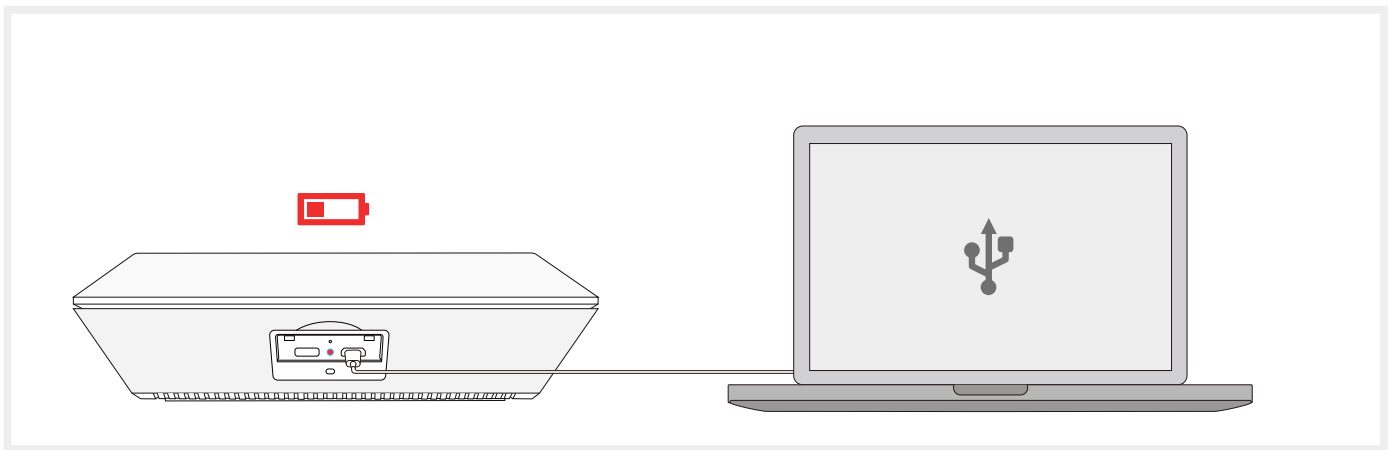

Connecting

1. Download the Nuroom App

- a) Find QR code on the tab of AW10 device or User Guide. Scan the QR code with your IOS/Andriod device to download NUROUM app.
- b) Visit <http://nuroom.com> to download the NUROUM app.
- c) Visit <http://nuroom.com/aw8M> from your IOS/Andriod device to download the app.

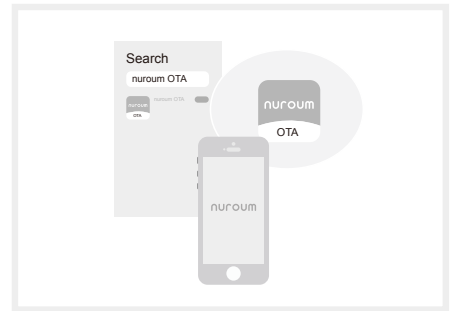
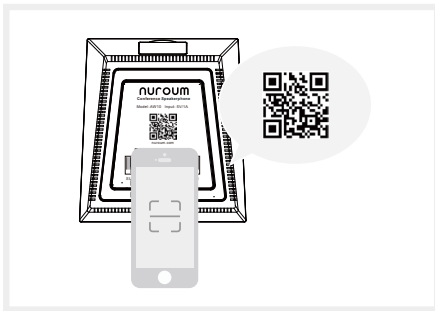

2. Firmware Update

Firmware updates always improves the performance and provides latest functionality and features of the NUROUM AW10.

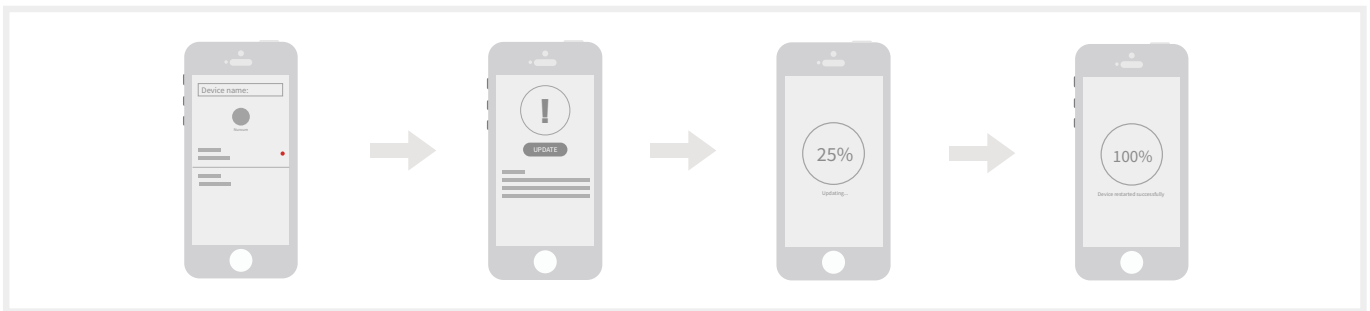

3. Device Name Modification

To personalize your speakerphone, or differentiate multiple speakerphones, the Nuroom app allows you to modify its device name.

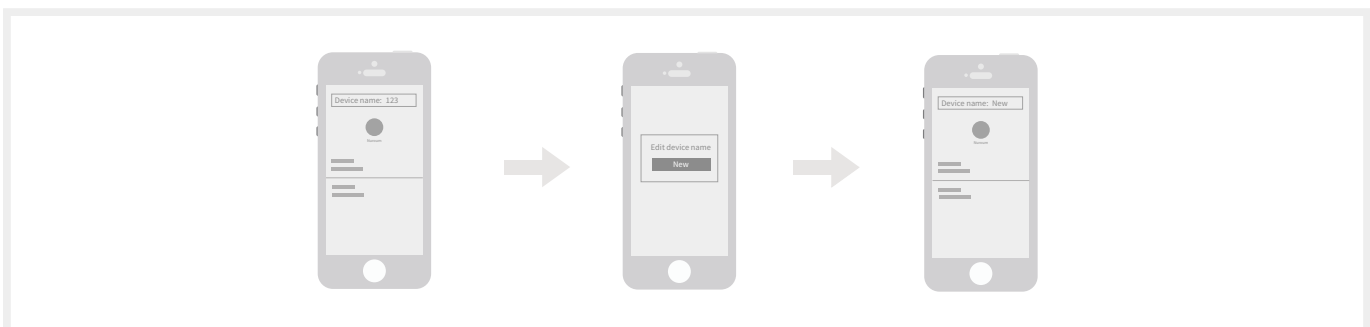

Notes & Warnings

Please read and follow all the safety instructions carefully .

- 1、 Use the included USB cable to charge the speakerphone.
- 2、 Unauthorized dismantling is dangerous and can cause damage to the speakerphone and built-in battery.
- 3、 Keep the device away from high-temperature environment or heat source, strong magnetic or electric field.
- 4、 Store the device in dry and cool places. Do not soak the device in water or any other liquid.
- 5、 Dispose of the packing materials, the whole device, battery and other electric components properly.
- 6、 The packing and the speakerphone contain small components that can be dangerous to children. Please keep the device out of children's reach.



Product Information

Dimensions	135 × 122 × 36mm	Weight	approx. 314g
USB Cable	Micro-USB	Battery Specification	3.7V/3600mAh
Charge Specification	5V --- 1A	Talk Time	Up to 30 hours
Microphones	MEMS	Speaker	4Ω3W
Connection Modes	USB/Bluetooth	Bluetooth Version	BT 5.0
Supported Bluetooth Profiles	HFP、A2DP、BLE	Bluetooth Distance	~ 10m (depends on your RF environment)